

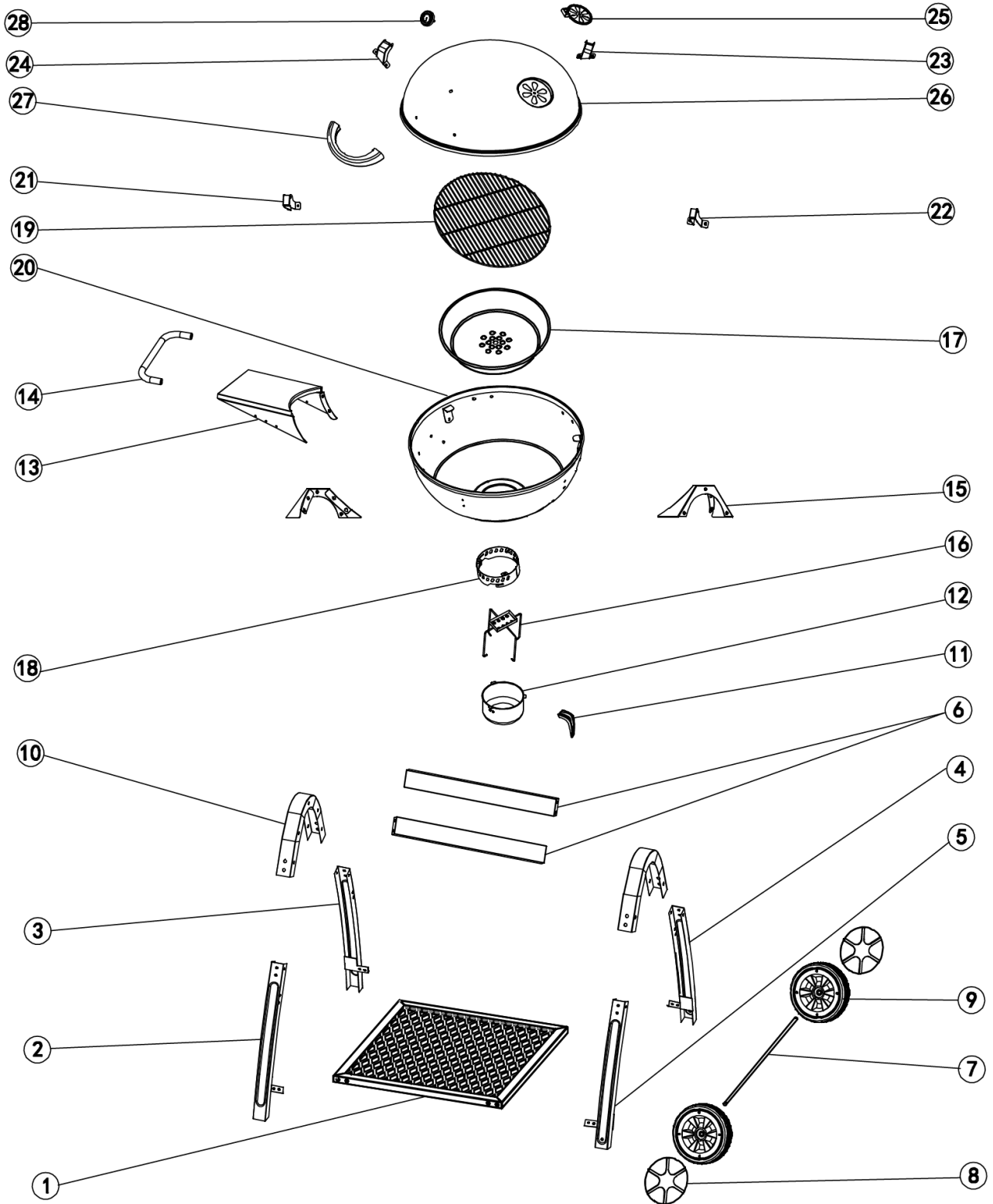

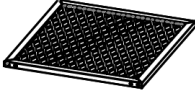











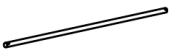

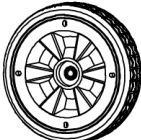
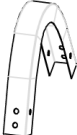

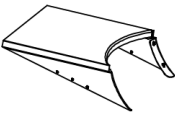

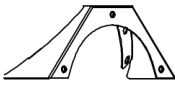
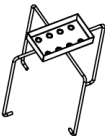
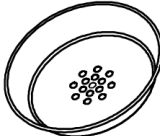

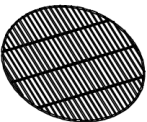

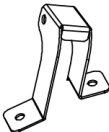
 HP2	 90min
---	---	--

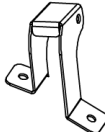

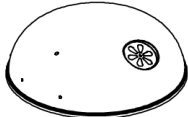
① *1 	② *1 (LF) 	③ *1 (LB) 	④ *1 (RB) 	⑤ *1 (RF) 	⑥ *2 
⑦ *1 	⑧ *2 	⑨ *2 	⑩ *2 	⑪ *1 	⑫ *1 
⑬ *1 	⑭ *1 	⑮ *2 	⑯ *1 	⑰ *1 	⑱ *1 
⑲ *1 	⑳ *1 	㉑ *1 	㉒ *1 	㉓ *1 	㉔ *1 
㉕ *1 	㉖ *1 	㉗ *1 	㉘ *1 		
A M6-12*57 		B M5-8*9 		C *2 	D M5*9 
E ϕ 1.5-28*4 		F M4-8*2 		G ϕ 6-35*2 	

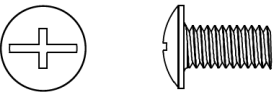
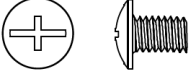
1

A			8PCS
----------	--	--	------

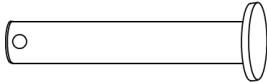
2

A			16PCS
----------	--	--	-------

3

C		2PCS
E		2PCS

4

A			6PCS
----------	--	--	------

5

A			8PCS
----------	--	--	------

6

B			4PCS
D			4PCS

7

A			3PCS
----------	--	--	------

8

F			2PCS
----------	--	--	------

9

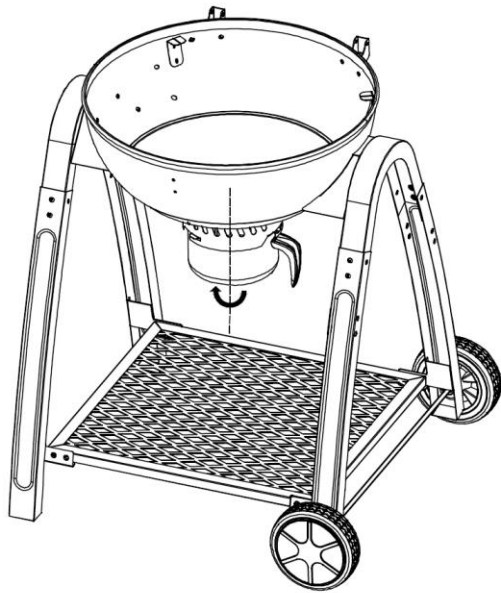

10

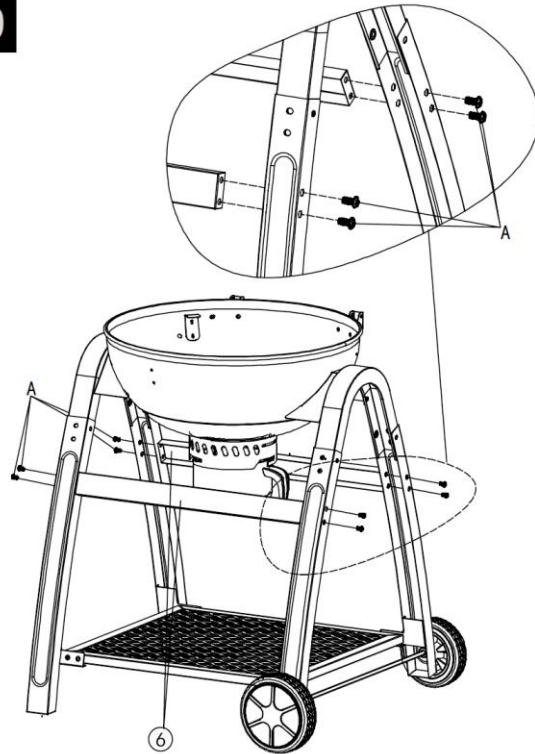

A

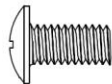

8PCS

11

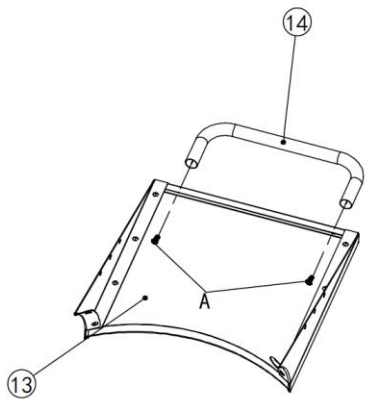

A

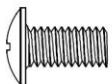

2PCS

12

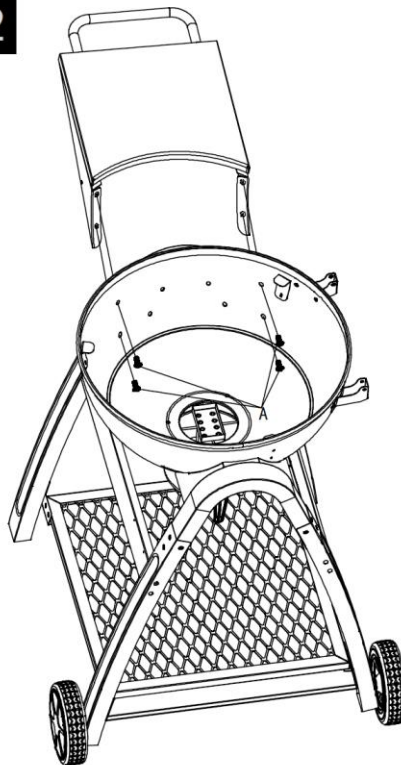

A

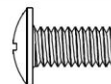

4PCS

13

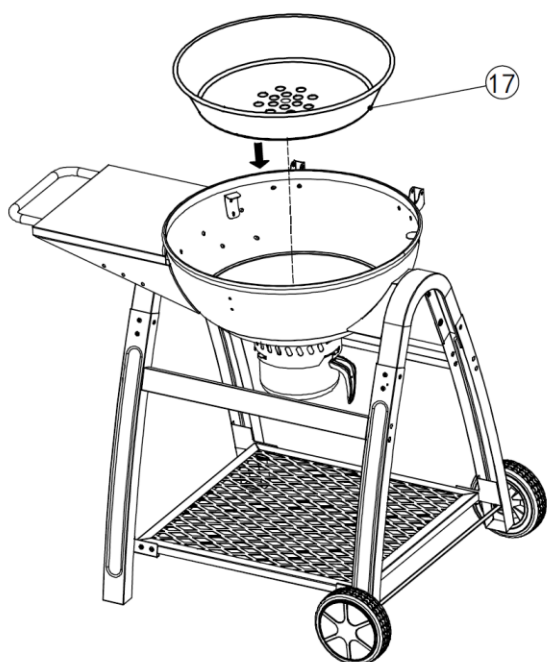

14

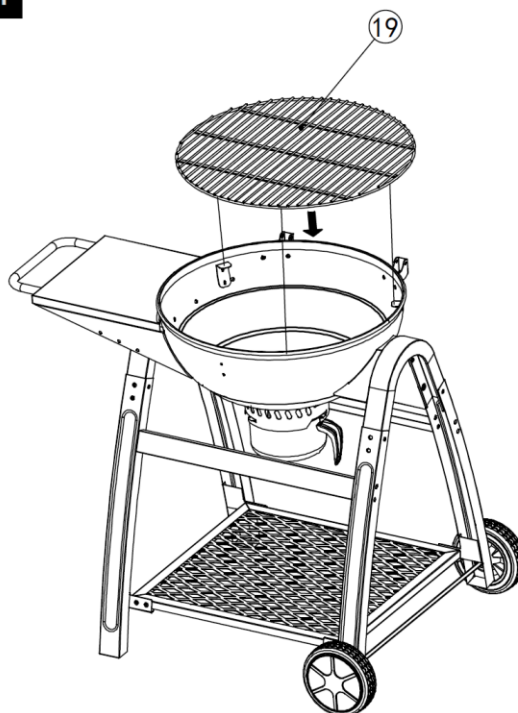

15

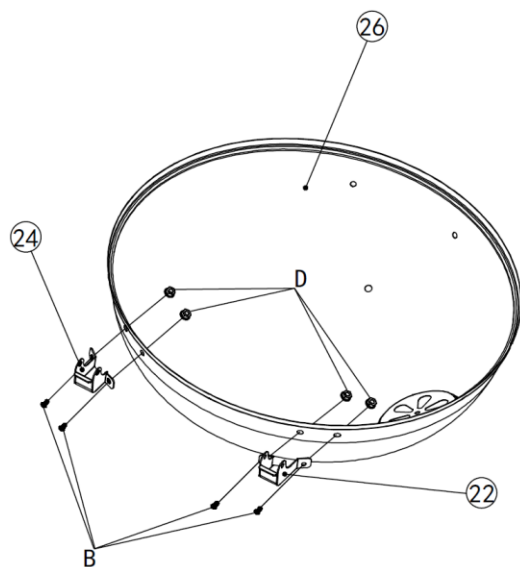

B			4PCS
D			4PCS

16

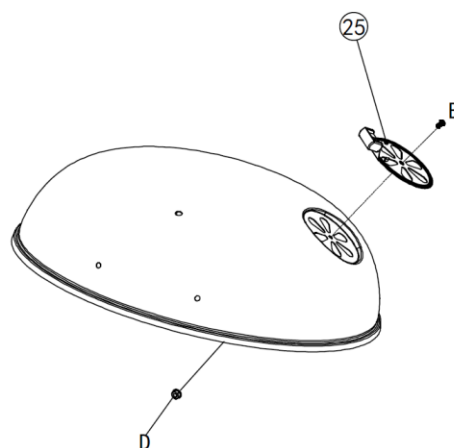

B			1PCS
D			1PCS

17

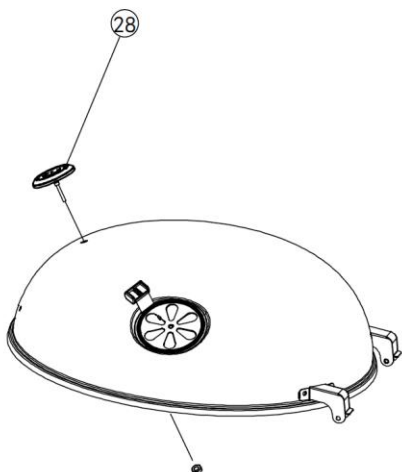

18

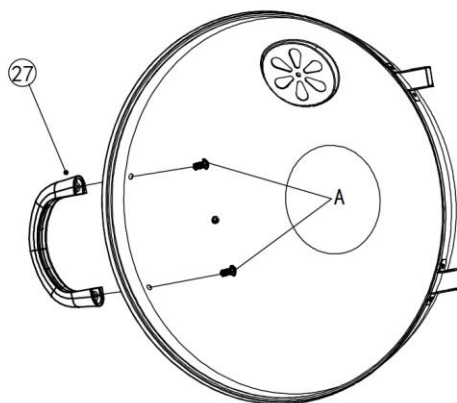

A			2PCS
---	--	--	------

19

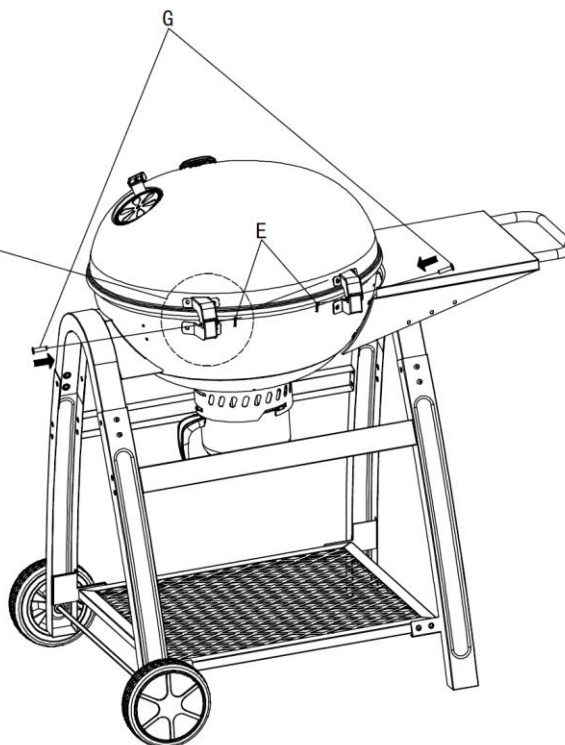
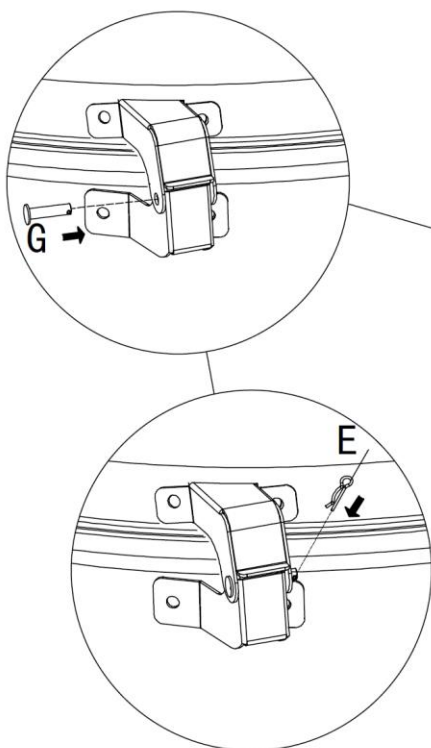

E		2PCS
---	--	------

G		2PCS
---	--	------